

48CSP2DR - 48CSP2DL : INSTRUCTION MANUAL

ACIM JOUANIN - 650, Rue Vulcain - ZI n°1 Nétreville - BP 1725 - 27017 EVREUX Cedex - France
www.acim-jouanin.fr export@acim-jouanin.fr Tel : 33 (0)2 32 62 34 20 Fax : 33 (0)2 32 62 34 29

Thank you for your purchasing “48CSP2D Temperature Controller.” Please check that the product is exactly the one you ordered and use it according to the following instructions. (Please refer to a separate operation manual for details.) Dealers are cordially requested to ensure the delivery of this Instruction Manual to hands of the end-users.

NOTICE

The contents of this document may be changed in the future without prior notice.

We paid the utmost care for the accuracy of the contents. However, we are not liable for direct and indirect damages resulting from incorrect descriptions, omission of information, and use of information in this document.

CONTENTS

CONTENTS	1	6-3 Self-tuning	21
Check of specifications and accessories	2	6-4 Alarm function [option]	23
The related documents	2	6-5 Ramp/soak function [option]	25
Safety Precautions	3	6-6 Communication function [option]	26
Index	9	6-7 Digital input (DI function) [option]	27
1. Installation/mounting	10	6-8 Other function	28
2. Wiring	12	6-9 Re-transmission output function	29
3. Usage (Read before using)	13	6-10 Remote SV function	29
4. Display and operation	14	7. Setting of input type and control algorithm	30
5. Setting methods of temperature and parameters	16	8. Error indications	32
1st block parameter	16	[Table 1] Input type code	33
2nd block parameter	17	[Table 2] Control output action code	33
3rd block parameter	18	[Table 3] Input range (Standard range)	34
6. Functions	19	[Table 4] Alarm action type code	35
6-1 ON/OFF control	19	[Table 5] Control operation type code	36
6-2 Auto-tuning (AT)	20	48CSP2D Model Code Configuration	37
		Specification	38

Check of specifications and accessories

Before using the controller, check if the type and specifications are as ordered.
(A table of Model code configuration is given in Page 37).



Check that all of the following accessories are included in the package box.

- Temperature controller----- 1 unit
- Instruction manual ----- 1 copy
- Mounting bracket ----- 1 pc.
- Watertight packing ----- 1 pc.

Safety Precautions

Before using this product, the user is requested to read the following precautions carefully to ensure the safety. Safety precautions must be taken by every user to prevent accidents.

The safety requirements are classified into “Warning” and “Caution” according to the following interpretations :

 Warning	Suggesting that the user's mishandling can result in personal death or serious injury.
 Caution	Suggesting that the user's mishandling can result in personal injury or damage to the property.

WARNING Over-temperature Protection

“Any control system design should take into account that any part of the system has the potential to fail”.

“For temperature control systems, continued heating should be considered the most dangerous condition, and the machine should be designed to automatically stop heating if unregulated due to the failure of the control unit or for any other reason”.

The following are the most likely causes of unwanted continued heating:

- 1) Controller failure with heating output constantly on
- 2) Disengagement of the temperature sensor from the system
- 3) A short circuit in the thermocouple wiring
- 4) A valve or switch contact point outside the system is locked to keep the heat switched on.

In any application where physical injury or destruction of equipment might occur, we recommend the installation of independent safety equipment, with a separate temperature sensor, to disable the heating circuit in case of overheating.

The controller alarm signal is not designed to function as a protective measure in case of controller failure.

1. Warning

1.1 Installation and wiring

- This controller designed to be installed at the following conditions.

Operating temperature	-10 to +50 [°C]	
Operating humidity	90%RH or less (Non condensation)	
Installation category	II	Conforming to IEC1010-1
Pollution degree	2	

- The controller must be installed such that with the exception of the connection to the mains, creepage and clearance distances shown in the table below are maintained between the temperature probe and any other assemblies which use or generate a voltage shown in the table below. Failure to maintain these minimum distances would invalidate the EN 61010 safety approval.

Voltage used or generated by any assemblies	Clearance (mm)	Creepage (mm)
Up to 50Vrms or Vdc	0.2	1.2
Up to 100Vrms or Vdc	0.2	1.4
Up to 150Vrms or Vdc	0.5	1.6
Up to 300Vrms or Vdc	1.5	3.0
Above 300Vrms or Vdc	Contact with our sales office.	

- If the voltage shown above exceeds 50Vdc (i.e. hazardous voltage), the basic insulation is required between all terminals of this controller and the ground, and supplementary insulation is required for the alarm output.

Isolation class of this controller is as shown below. Be sure to check that the isolation class of the controller satisfies your requirements before installation.

—— : Basic insulation, - - - - - : Non-insulation, ——— : Functional insulation

Mains (Power source)	Measured value input, CT input, Remote SV input
Control output1 (relay output)	Internal circuit
Control output2 (relay output)	Control output1, 2 (SSR drive output / Current output)
Alarm output (AL1)	Re-transmission
Alarm output (AL2)	Communication (RS-485) circuit
Alarm output (AL3) or Heater burnout alarm output (HB)	Digital input (DI).

- If there is a danger of a serious accident resulting from a failure or a defect in this unit, provide the unit with an appropriate external protective circuit to prevent an accident.
- The unit is normally supplied without a power switch and fuses.
Make wiring so that the fuse is placed between the main power supply switch and this controller. (Main power supply: 2 pole breaker, fuse rating: 250V, 1A)
- When wiring the power supply terminal, use vinyl insulated 600 volt cable or equivalent.
- To avoid the damage and failure of controller, supply the power voltage fitting to the rating.
- To avoid an electric shock and controller failure, do not turn ON the power before all wiring is completed.
- Be sure to check that the distance is kept to avoid electric shock or firing before turning the power ON.
- Keep away from terminals while the circuit is energized in order to avoid an electric shock and a malfunction.
- Never attempt to disassemble, fabricate, modify, or repair this unit because tampering with the unit may result in a malfunction, electric shock, or a fire.

1.2 Maintenance precautions

- Be sure to turn off the power before this controller is installed or removed in order to avoid an electric shock, malfunction, and fault.
- Regular maintenance is recommended a longer service life of this controller.
Some parts of this controller have a limited life span, or they will be deteriorated with the lapse of time.
- One-year warranty is guaranteed for this unit including accessories, provided that the controller is properly used.

2. Caution

2.1 Cautions on installation

Avoid the following places for installation.

- a place where the ambient temperature may reach beyond the range of from 0 to 50°C while in operation.
- a place where the ambient humidity may reach beyond the range of from 45 to 85% RH while in operation.
- a place where a change in the ambient temperature is so rapid as to cause condensation.
- a place where corrosive gases (sulfide gas and ammonia gas, in particular) or combustible gases are emitted.
- a place where the unit is subject directly to vibration or shock.
(Vibration or shock may cause output relay malfunction.)
- a place exposed to water, oil, chemicals, steam and vapor.
(if immersed with water, take the inspection by sales office to avoid an electrical leakage and firing)
- a place where the unit is exposed to dust, salt air, or air containing iron particles.
- a place where the unit is subject to interference with static electricity, mag netism, and noise.
- a place where the unit is exposed to direct sunlight.
- a place where the heat may be accumulated due to the radiation of heat.

2.2 Caution on installation on panel

- Insert the mounting bracket (accessory) from the rear side until the main unit is securely fit into the panel. If there are some gaps, tighten two screws until the gaps are eliminated. (Do not tighten the screws excessively because the mounting bracket can be removed from the stopper by the force.)
- The front side of this controller conforms to NEMA4X (equivalent with IP66). To ensure the waterproofness between the instrument and the panel, use packings that are provided as accessories in the following manner: (The improper fitting of packings will ruin the waterproofness.)
 - 1 - As shown in Figure 1, fit a packing to the case of the unit and then insert it in the panel.
 - 2 - Tighten screws on the fixing frame or fixtures so that no gaps are given between the front of controller and packing and between panels. Check that there are no deformation of packing as shown in Fig.3.
- If panel strength is weak, it may causes a gap between the packing and the panel, thus impairing water resistance.

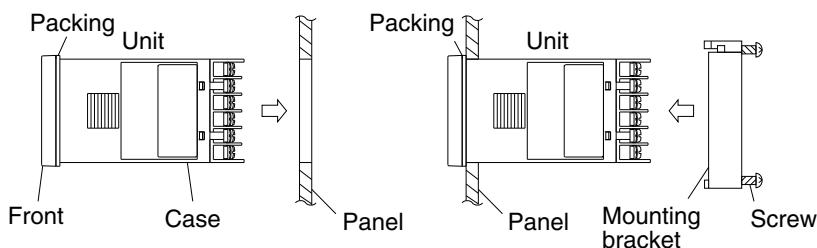

Figure 1

Figure 2

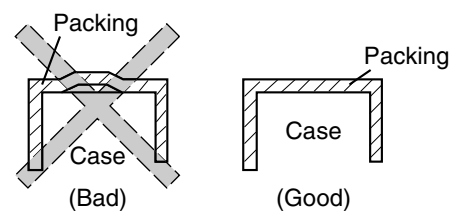
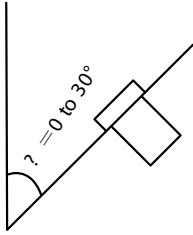

Figure 3

Standard : Vertical mounting, flush on the panel. (The controller is horizontal.)

When mounting the controller on tilted surface, the maximum tilt angle is 30° (degree) from vertical.



(Caution)

- Don't block the openings around the controller, or radiation effect will be reduced.
- Don't block the ventilation openings at the top of the terminal block.

2.3 Precautions in wiring connection

- For the thermocouple sensor type, use thermocouple compensation wires for wiring. For the RTD type, use a wiring material with a small lead wire resistance and no resistance differentials among three wires.
- Keep input lines away from power line and load line to avoid the influence from noise induced.
- For the input and output signal lines, be sure to use shielded wires and keep them away from each other.
- If a noise level is excessive in the power supply, the additional installation of an insulating transformer and the use of a noise filter are recommended.

(example: ZMB22R5-11 Noise Filter manufactured by TDK)

Make sure that the noise filter is installed to a place such as a panel that is properly grounded. The wiring between the noise filter output terminal and the instrument power supply terminal should be made as short as possible. None of fuses or switches should be installed to the wiring on the noise filter output side because the filter effect will be degraded by such a installation.

- A better anti-noise effect can be expected by using stranded power supply cable for the instrument. (The shorter the stranding pitch is, the better the anti-noise effect can be expected.)
- For the unit with an alarm against a failure (burn-out) in the heater, use the same power line for connection of the power supplies for the heater and the controller.
- A setup time is required for the contact output when the power is turned on. If the contact output is used as a signal for an external interlock circuit, use a delay relay at the same time.
- Use the auxiliary relay since the life is shortened if full capacity load is connected to the output relay. SSR/SSC drive output type is preferred if the output operations occur frequently.

[Proportional interval] relay output : 30 seconds or more,

SSR/SSC : one second or more

- If inductive load such as magnetic switches connected as a relay output load, it is recommended to use Z-Trap to protect a contact from switching surge and keep a longer life.

Model : ENE241D-05A (power supply voltage: 100 V)

ENE471D-05A (power supply voltage: 200 V)

Where to install : Connect it between contacts of the relay control output.

Example

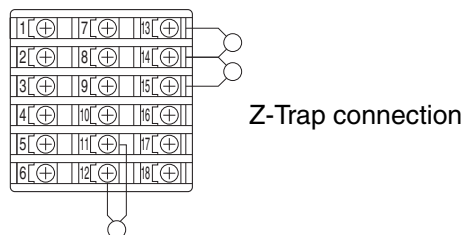

2.4 Requirement for key operation/operation in abnormalities

- Prior to the operation, be sure to check alarm functions, since a failure in the proper setting will result in a failure in the proper output of an alarm in case of an abnormality.
- A display of UUUU or LLLL will appear in case of a break in the input. Be sure to turn off the power when a sensor is replaced.

2.5 Others

- Do not use organic solvents such as alcohol and benzene to wipe this controller. Use a neutral detergent for wiping the controller.

Index

<Reference items>	<Description>
Confirming type specification	<ul style="list-style-type: none"> • Confirming that the delivered controller is equal to the ordered one.
↓	
1 Installation/mounting	<ul style="list-style-type: none"> • Outline dimensions • Panel cutout dimensions • Mounting method on the panel
↓	
2 Wiring	
↓	<ul style="list-style-type: none"> • Terminal connection diagram
Power on	
↓ *Note	
3 Usages	
4 Display and operation	
5 Setting method of temperature and parameters	
6 Functions	
↓	
7 Setting of input type and control method.	
↓	
Operation	
↓	
8 Error indications	

(Note) *To start the operation, wait for about 30 minutes after the power-on for warm up.

1 Installation/mounting

Outline and Panel Cutout Dimensions

Outline dimensions (unit:mm)

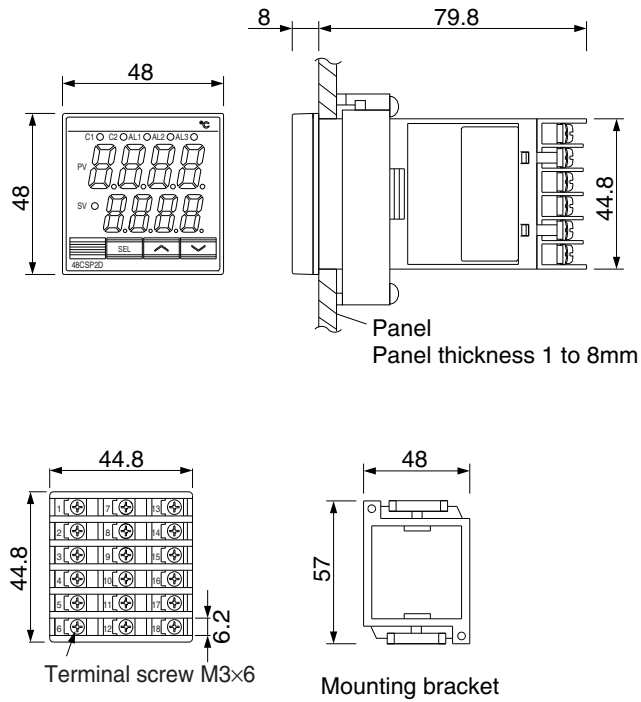

Panel cutout dimensions (unit:mm)

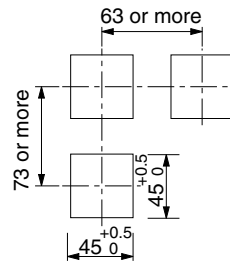

For side by side installation,
see the Note1.

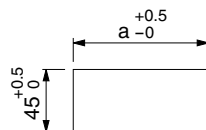

Number of units	2	3	4	5	6
a	93	141	189	237	285

Remarks

Note1) Panel coating procedure must be taken into account, for the panel cutout dimension should still conform with the dimensions listed in the left hand column.

Caution on side-by-side installation:

- Maximum ambient temperature is at 45 °C when the power supply is at 200VAC or more. When the 48CSP2D controller is tightly fixed in vertical and upright direction, the use of 100V AC power supply is recommended .
(Installation of fan is recommended as a heat release measure)
- Make sure the controller is installed more than 30mm away, when there is an instrument of more than 70mm depth or a wall on the right side of the controller.
- Side-by-side installation may sacrifice the controller's waterproof property.

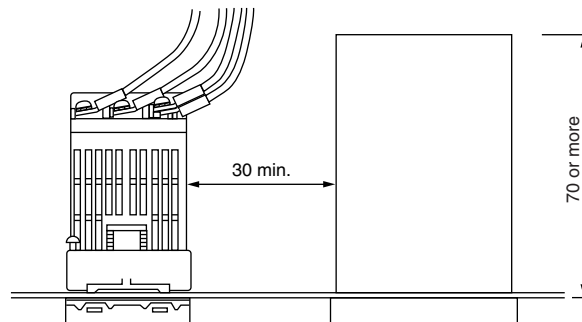

Caution on wiring:

- Terminals at the left hand side (from No.1 to 6) should be used first.
- Crimp terminals with matching screw size should be used. Tightening torque value should be approx. 0.8N · m.
- Do not connect anything to the terminals that are not used. (Do not use as relay terminal)

2

Wiring

Terminal Connection Diagram (100 to 240 AC)

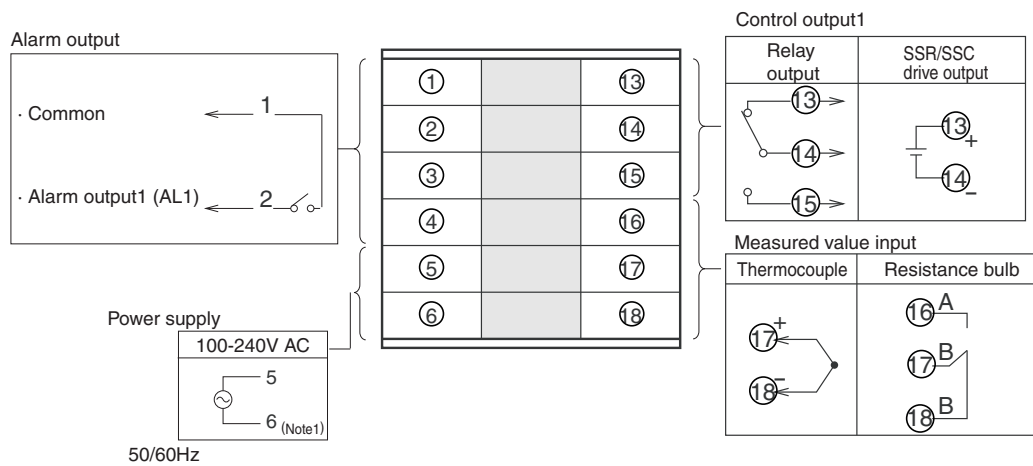

Note 1 : Check the power supply voltage before installation.

48CSP2DR : RELAY OUTPUT

48CSP2DL : SSR/SSC drive output

3 Usage (Read before using)

Name of Functional Parts and Functions

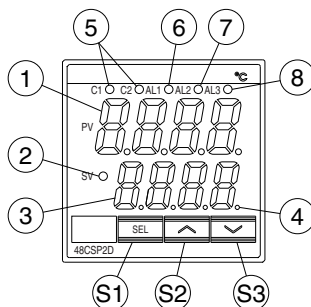

Setting keys

	Name	Function
Ⓢ1	Select key	The key shifting to the 1st, the 2nd or the 3rd block parameter, switching the display between parameter and the data at the 1st, the 2nd and the 3rd block.
Ⓢ2	Up key	<ul style="list-style-type: none"> · The numerical value is increased by pressing the key once. The numerical value keeps on increasing by pressing the key continuously. · For searching parameters within the 1st, the 2nd and the 3rd block.
Ⓢ3	Down key	<ul style="list-style-type: none"> · The numerical value is decreased by pressing the key once. The numerical value keeps on decreasing by pressing the key continuously. · For searching parameters within the 1st, the 2nd and the 3rd block.

Display/Indication

	Name	Function
1	Process value (PV)/parameter name display	<ol style="list-style-type: none"> 1) Displays a process value (PV). 2) Displays the parameter symbols at parameter setting mode. 3) Displays various error indications (refer to "8. Error indications").
2	Set value (SV) indication lamp	The lamp is lit while a set value (SV) is displayed.
3	Set value (SV)/parameter setting display	<ol style="list-style-type: none"> 1) Displays a set value (SV). 2) Display the parameter settings at parameter setting mode. 3) Flickers at Standby mode. 4) Displays the set value (SV) and "SV-1" alternately when the SV switching function is used. 5) Displays the set value (SV) and "rSV" alternately while in remote operation.
4	Auto-tuning/self-tuning indicator	The lamp flickers while the PID auto-tuning or the self-tuning is being performed.
5	Control output indication lamp	<p>C1 : The lamp is lit while the control output 1 is ON.</p> <p>C2 : The lamp is lit while the control output 2 is ON. (Note 1)</p>
6	Alarm output 1 (AL1) indication lamp (Note 1)	<p>The lamp is lit when the alarm output 1 is activated.</p> <p>It flickers during ON-delay operation. (Note 2)</p>

Note 1) Control output 2 and alarm function are optional.

Note 2) The lamp does not flicker while the timer is activated.

4

Display and operation

Standby mode

· To perform standby operation, set "STby" as ON in the 1st block parameter.

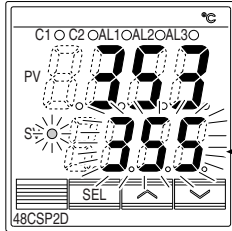

· Standby mode:

(Output) Control outputs (1 and 2) and alarm outputs (all) are not provided. However, depending on setting of "P-n1", control action, control outputs are provided at the abnormal input.

No alarm output is provided at standby mode, even in (Fault-condition).

Caution Be careful since the equipment does not provide output of the alarm of the main unit abnormality during the standby operation.

(Control) Control is not performed.

(Display) SV display flickers.

Caution The SV display does not flicker while the 1st, 2nd and 3rd block parameters are displayed.

(Setting) SV and parameter settings are able to perform.

Switching by 1st block ST by settings

Operation mode

1 Change of set value (SV)

When the SV lamp is lit, the set value (SV) is displayed at the lower line.

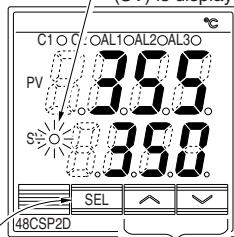

The set value (SV) can be changed.

Caution After the data setting, the data are registered automatically in 3 seconds.

2 Shift to the 1st, 2nd and 3rd block parameter

To shift to the other blocks, press the **SEL** key.

Caution Depending on the pressing time of **SEL** key, you can select the block to shift.

SEL pressing time	Shifting block
About 1 sec pressing	1st block
About 3 sec pressing	2nd block
About 5 sec pressing	3rd block

Switching by the **SEL** key

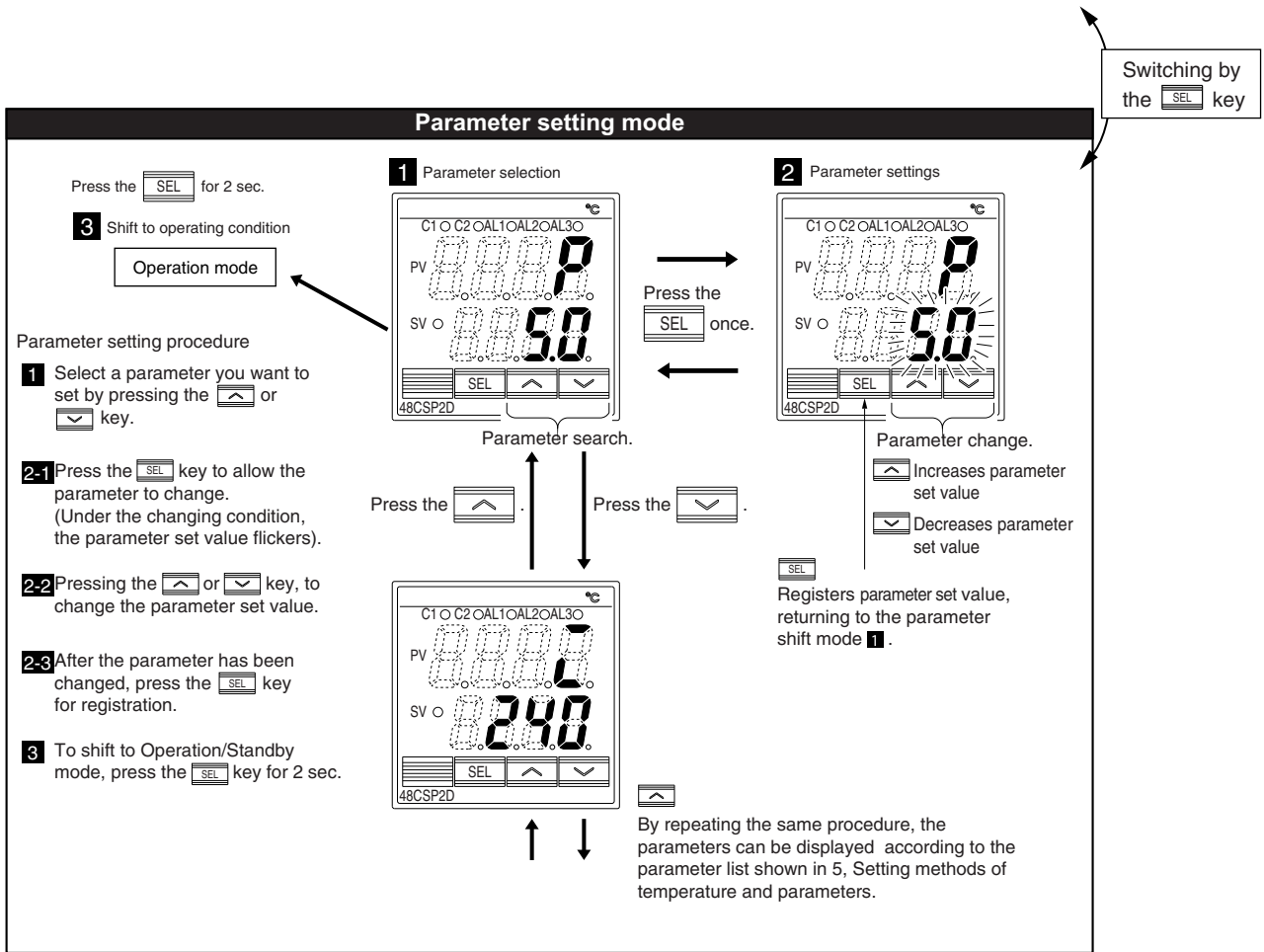

Note: If the upper display (PV) comes off (or kept distinguished), make the setting once again by adding 64 to the set value of parameter DP13.

5

Setting methods of temperature and parameters

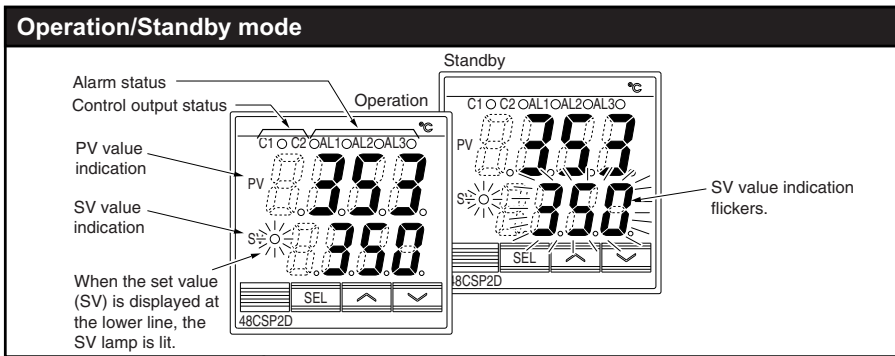

If no operation status continues for 30 seconds, the screen is restored to the PV/SV display just after the power is turned on.

Press for about 1 sec.



Press for about 2 sec.



1st block parameter

Parameter display symbol	Parameter	Description of contents	Default setting	Remarks																																							
<i>STbY</i>	STbY	Standby settings	Switches RUN or Standby of the control. ON: Control standby (output: OFF, alarm: OFF) OFF: Control RUN	OFF																																							
<i>CMod</i>	CMod	Control mode	Switches Local and Remote operations. <i>LoCL</i> : Local operation <i>REn</i> : Remote operation	<i>LoCL</i>																																							
<i>ProG</i>	ProG	Ramp/soak control	OFF: stop, rUn: Start, HLd: status hold	OFF																																							
<i>LACH</i>	LACH	Alarm latch cancel	Releases alarm latch. 1: Alarm latch release	0																																							
<i>AT</i>	AT	Auto-tuning	0: Stop, 1: Standard AT start, 2: Low PV type AT start	0																																							
<i>TM-1</i>	TM-1	Timer 1 display	Time displays indicating the remaining time at the timer mode.	-																																							
<i>TM-2</i>	TM-2	Timer 2 display		-																																							
<i>TM-3</i>	TM-3	Timer 3 display		-																																							
<i>AL1</i>	AL1	Alarm 1 set value	(appears only with alarm action type 1 to 10). Setting range: Note 1	10																																							
<i>A1-L</i>	A1-L	Alarm 1 low limit set value	(appears only with alarm action type 16 to 31). Setting range: Note 1	10																																							
<i>A1-H</i>	A1-H	Alarm 1 high limit set value	(appears only with alarm action type 16 to 31). Setting range: Note 1	10																																							
<i>AL2</i>	AL2	Alarm 2 set value	(appears only with alarm action type 1 to 10). Setting range: Note 1	10																																							
<i>A2-L</i>	A2-L	Alarm 2 low limit set value	(appears only with alarm action type 16 to 31). Setting range: Note 1	10																																							
<i>A2-H</i>	A2-H	Alarm 2 high limit set value	(appears only with alarm action type 16 to 31). Setting range: Note 1	10																																							
<i>AL3</i>	AL3	Alarm 3 set value	(appears only with alarm action type 1 to 10). Setting range: Note 1	10																																							
<i>A3-L</i>	A3-L	Alarm 3 low limit set value	(appears only with alarm action type 16 to 31). Setting range: Note 1	10																																							
<i>A3-H</i>	A3-H	Alarm 3 high limit set value	(appears only with alarm action type 16 to 31). Setting range: Note 1	10																																							
<i>LoC</i>	LoC	Key lock	Setting of key lock status. <table border="1" style="margin-left: auto; margin-right: auto;"> <thead> <tr> <th rowspan="2">LoC</th> <th colspan="2">All parameters, MV</th> <th colspan="2">SV</th> </tr> <tr> <th>Front key</th> <th>Comm-unication</th> <th>Front key</th> <th>Comm-unication</th> </tr> </thead> <tbody> <tr> <td>0</td> <td>○</td> <td>○</td> <td>○</td> <td>○</td> </tr> <tr> <td>1</td> <td>×</td> <td>○</td> <td>×</td> <td>○</td> </tr> <tr> <td>2</td> <td>×</td> <td>○</td> <td>○</td> <td>○</td> </tr> <tr> <td>3</td> <td>○</td> <td>×</td> <td>○</td> <td>×</td> </tr> <tr> <td>4</td> <td>×</td> <td>×</td> <td>×</td> <td>×</td> </tr> <tr> <td>5</td> <td>×</td> <td>×</td> <td>○</td> <td>×</td> </tr> </tbody> </table>	LoC	All parameters, MV		SV		Front key	Comm-unication	Front key	Comm-unication	0	○	○	○	○	1	×	○	×	○	2	×	○	○	○	3	○	×	○	×	4	×	×	×	×	5	×	×	○	×	0
LoC	All parameters, MV		SV																																								
	Front key	Comm-unication	Front key	Comm-unication																																							
0	○	○	○	○																																							
1	×	○	×	○																																							
2	×	○	○	○																																							
3	○	×	○	×																																							
4	×	×	×	×																																							
5	×	×	○	×																																							

Table 4
(Page 35)
Note 1

○: Setting enable, ×: Setting disable

Note 1) Setting range : 0 to 100%FS (in case of absolute value alarm)
-100 to 100%FS (in case of deviation alarm)

Operation/Standby mode

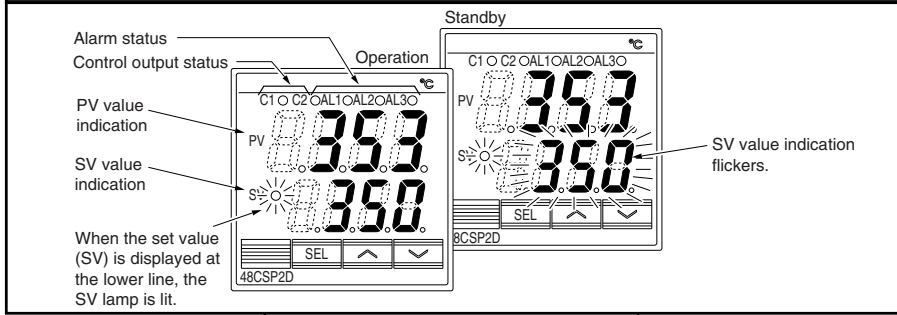

If no operation status continues for 30 seconds, the screen is restored to the PV/SV display just after the power is turned on.

2nd block parameter

Parameter display symbol	Parameter	Description of contents	Default setting	Remarks	
P	P	Proportional band	Setting range: 0.0 to 999.9% ON/OFF control when "P" = 0	5.0	
\bar{c}	I	Integral time (reset)	Setting range: 0 to 3200 sec. No integral action when "I" = 0	240	
d	D	Derivative action time	Setting range: 0.0 to 999.9 sec. No derivative action when "d" = 0	60.0	
HYS	HYS	Hysteresis for ON/OFF control	Setting range: 0 to 50% FS	1	
$Cool$	Cool	Proportional band coefficient on cooling side	Sets the proportional band coefficient on the cooling side. (Setting range: 0.0 to 100.0) ON/OFF control when "Cool" = 0	1.0	
db	db	Deadband/overlap	Shifts the output value on the cooling side. (Setting range: -50.0 to 50.0%)	0.0	
$Ctrl$	CTRl	Control algorithm	Type of control algorithm. (Setting range: PID, FUZZY, SELF)	PID	
TC	TC	Cycle time (control output 1)	Sets cycle time of control output 1. (Setting range: 1 to 150 sec)	30/2	Note 2
$TC2$	TC2	Cycle time (control output 2)	Sets cycle time of control output 2. (Setting range: 1 to 150 sec)	30/2	Note 2
$P-n2$	P-n2	Input type code	Type of input	As ordered	Table 1 (Page 33)
$P-SL$	P-SL	Lower limit of input range	Lower limit of input range (Setting range: -1999 to 9999)	As ordered	Table 3 (Page 34)
$P-SU$	P-SU	Upper limit of input range	Upper limit of input range (Setting range: -1999 to 9999)	As ordered	
$P-dP$	P-dP	Setting of decimal point position	Select a decimal point position of display. (Setting range: 0 to 2) 	As ordered	
$PVOF$	PVOF	PV offset	Shift the display of process value (PV). (Setting range: -10 to 10%FS)	0	
$P-dF$	P-dF	Time constant of input filter	Time constant (Setting range: 0.0 to 900.0 sec.)	5.0	
$ALN1$	ALM1	Type of alarm 1	Setting types of alarm action (Setting range: 0 to 34)	0/5	Table 4 (Page 35)
$ALN2$	ALM2	Type of alarm 2		0/9	
$ALN3$	ALM3	Type of alarm 3		0	
$STAT$	STAT	Ramp/soak status	Displays the current Ramp/Soak status. No setting can be made.	-	
PTn	PTn	Ramp/soak execute type	Selects the ramp/soak execute type. 1: Executes 1st to 4th segment. 2: Executes 5th to 8th segment. 3: Executes 1st to 8th segment.	1	
$SV-1$ to $SV-8$	SV-1 to SV-8	Ramp target SV-1 to SV-8	Sets the target SV for each ramp segment. (Setting range: 0 to 100%FS)	0%FS	
$TM1r$ to $TM8r$	TM1r to TM8r	1st ramp segment time to 8th ramp segment time	Sets the time for each ramp segment. (Setting range: 0 to 99 hours and 59 minutes)	0.00	
$TM1S$ to $TM8S$	TM1S to TM8S	1st soak segment time to 8th soak segment time	Sets the time for each soak segment. (Setting range: 0 to 99 hours and 59 minutes)	0.00	
Mod	Mod	Setting of ramp/soak mode	Sets ramp/soak operation mode	0	Table 5 (Page 36)

Note 2) When using the heater break alarm, set the parameter "TC" to 20 or more.

Set the CT (current transformer) so that it measures the current of the heater connected to the control output 1.

Disconnection of the control output 2 cannot be detected.

Never set "TC" / "TC2" = 0.

Some parameters may not be displayed on the screen, depending upon the types.

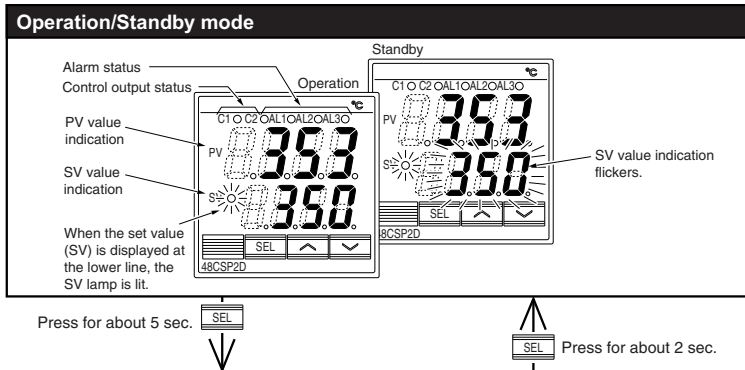

If no operation status continues for 30 seconds, the screen is restored to the PV/SV display just after the power is turned on.

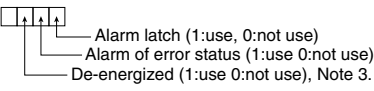
3rd block parameter					
Parameter display symbol	Parameter	Parameter	Description of contents	Default setting	Remarks
P-n1	P-n1	Control action	Selects the control action.	0/4	Table 2 (Page 33)
SV-L	SV-L	Lower limit of SV	Lower limit of SV (Setting range: 0 to 100%FS)	0%FS	
SV-H	SV-H	Upper limit of SV	Upper limit of SV (Setting range: 0 to 100%FS)	100%FS	
dLY1	dLY1	ON delay time of alarm 1	ON delay time setting for alarm output (Setting range: 0 to 9999 sec)	0	
dLY2	dLY2	ON delay time of alarm 2		0	
dLY3	dLY3	ON delay time of alarm 3		0	
CT	CT	Heater current value	Indicates the heater current value.	-	
Hb	Hb	HB alarm set value	Sets current value to detect the heater break alarm (Setting range: 1.0 to 50.0A, 0: OFF)	0.0	Note 2
A1hY	A1hY	Hysteresis for alarm 1	Sets ON-OFF hysteresis for alarm output. (Setting range: 0 to 50%FS)	1	
A2hY	A2hY	Hysteresis for alarm 2		1	
A3hY	A3hY	Hysteresis for alarm 3		1	
A1oP	A1oP	Additional function of alarm 1	Additional function of alarm output (Setting range: 000 to 111) 	000	
A2oP	A2oP	Additional function of alarm 2		000	
A3oP	A3oP	Additional function of alarm 3		000	
di-1	di-1	DI1 function	Selects digital input 1 (DI1) function (Setting range: 0 to 12)	0(OFF)	6-7 (Page 27)
di-2	di-2	DI2 function	Selects digital input 2 (DI2) function (Setting range: 0 to 12)	0(OFF)	6-7 (Page 27)
STno	STno	Station No.	Communication station No. (Setting range: 0 to 255)	1	
CoM	CoM	Parity setting	Parity setting. Baud rate is fixed at 9600 bps. (Setting range: 0 to 2)	0	6-6 (Page 26)
PCoL	PCoL	Communication protocol	Switches communication protocols. 1: Modbus protocol 2: Z-ASCII protocol	As ordered	
Ao-T	Ao-T	Re-transmission output type	Switches signals to be output for Re-transmission 0: PV, 1: SV, 2: MV, 3: DV	0	
Ao-L	Ao-L	Re-transmission output scale lower limit	Lower limit of the scaling for Re-transmission output (Setting range: -100 to 100%)	0	
Ao-H	Ao-H	Re-transmission output scale upper limit	Upper limit of the scaling for Re-transmission output (Setting range: -100 to 100%)	100	
rEMO	rEMO	Remote SV input zero point adjustment	Zero point compensation value for remote SV input (Setting range: -50 to 50%FS)	0	
rEMS	rEMS	Remote SV input span point adjustment	Span point compensation value for remote SV input (Setting range: -50 to 50%FS)	0	
r-dF	r-dF	Remote SV input filter constant	Filter time constant for remote SV input (Setting range: 0.0 to 900.0 second)	0.0	
rSV	rSV	Remote SV input value	Remote SV input value (industrial value) (Display only: -1999 to 9999)	-	
dSP1 to dSP13	dSP1 to dSP13	Parameter mask	Specifying parameter mask		

- Note 2) When using the heater break alarm, set the parameter "TC" to 20 or more.
Set the CT (current transformer) so that it measures the current of the heater connected to the control output 1.
Disconnection of the control output 2 cannot be detected.
Never set "TC" / "TC2" = 0.
- Some parameters may not be displayed on the screen, depending upon the types.
- Note 3) De-energized: Contact opens when the alarm "ON".

6 Functions

6-1 ON/OFF control

- At ON/OFF control mode, output signal is as shown below.
Set parameter "P" = 0 for selecting the ON/OFF control mode.
Set the hysteresis to avoid chattering.
(Default setting: HYS = 1)

- Parameter setting and operation example

Example 1 : Reverse operation

Parameter	Setting value
P	0.0
P-n1	0 (or 1)
HYS	Any value

Relation between PV and SV	Output
PV > SV	OFF
PV < SV	ON

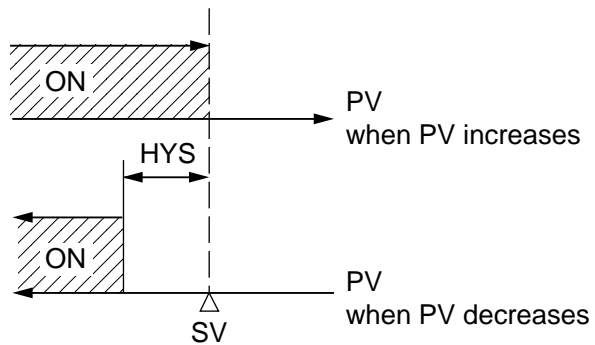

Example 2 : Direct operation

Parameter	Setting value
P	0.0
P-n1	2 (or 3)
HYS	Any value

Relation between PV and SV	Output
PV > SV	ON
PV < SV	OFF

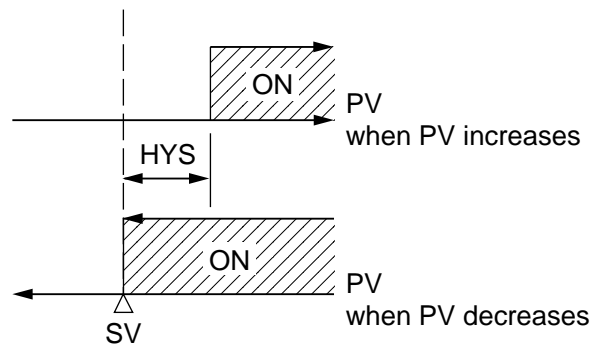

6-2 Auto-tuning (AT)

Autotuning is the automatic calculation and entering of the control parameters (P,I and D) into memory. Prior to the auto-tuning, complete the setting of input range

(P-SL,P-SU, P-dP), a set value (SV), alarm setting (AL1, AL2), and cycle time (TC).

How to start the auto-tuning

Set the parameter AT as either "1" or "2" by using \triangle or ∇ key, and press the SEL key to start the auto-tuning. Then the point indicator at the lower right starts blinking. At the completion of Auto-tuning, the point indicator stops blinking, then parameter AT is automatically set to 0.

	When auto-tuning is cancelled or not performed.	Standard type (auto-tuning at SV)	Low PV type (auto-tuning at 10%FS below SV.)
Setting code (AT)	0	1	2

① Standard type (AT=1)

② Low PV type (AT=2) : Overshoot decreased at tuning.

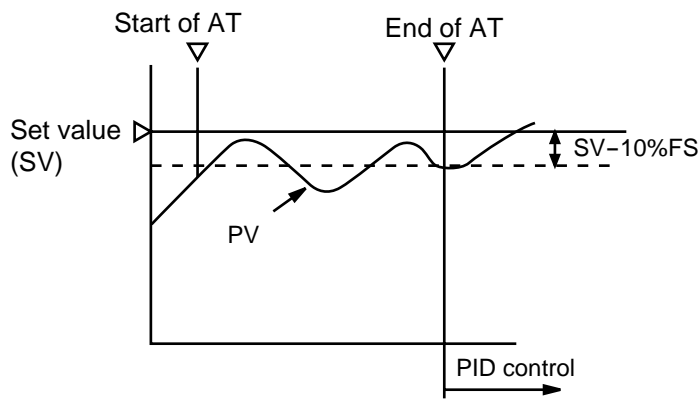
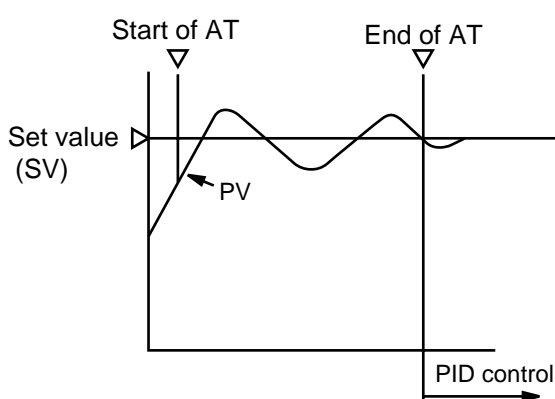

- The P.I.D. parameter calculated by auto-tuning remains even if the power is turned off. If the power is turned off before the auto-tuning is completed, you must restart the auto-tuning.
- The PV may be changed greatly depending on the process, because the control output is ON/OFF action (two position operation) in the auto-tuning. So, do not use the auto-tuning if the process does not allow a significant variation of PV.
In addition, the auto-tuning should not be used in any process such as pressure control and flow control, where a quick-response is required.
- If the auto-tuning isn't completed in four hours, the auto-tuning is suspected to fail. In this case, check the wiring and parameters such as the control action, input type, etc.
- Carry out the auto-tuning again, if there is any change in SV, input range (P-SL, P-SV or P-dP) or process condition. Perform the auto-tuning if fuzzy control is selected as the control algorithm.
- While carrying out auto-tuning, PV operates as shown in Figs 1 and 2.
- Execute the auto-tuning also when fuzzy control is selected in control type setting.
- When resetting the AT parameter, set the parameter to "0" once, then reset it.

6-3 Self-tuning

1) At power on, changing a set value or the external disturbance, tuning is made automatically so that the PID parameters are re-optimized.

It is useful where modification of PID parameters is required repeatedly due to frequent change in process condition.

If high controllability is important, select the PID or fuzzy control algorithm and use auto-tuning.

2) Setting for self-tuning

- ① Turn on the power and set the SV.
- ② Select SELF at "CTrL" (control algorithm) parameter.
- ③ Turn off the power once.
- ④ Turn on the power of the whole system. The controller should be turned on at the same time with the other equipments or even later. Otherwise, the self-tuning might not be performed successfully.
- ⑤ Self-tuning starts. Then the point indicator at the lower right corner starts blinking until the PID parameters are re-optimized.

Note) Whenever it is necessary to re-try the self-tuning, please set "CTrL" = PID once, and then start the above setting procedure from the beginning.

2nd block parameter

PV CTrL
 SV ○ PId

→

PV CTrL
 SV ○ SELF

· Set "CTrL" (control algorithm) as SELF.

PID	PID control
FUZY	Fuzzy control
SELF	Self-tuning control

⚠ Caution ⚠ Setting "CTrL" to SELF starts self-tuning.

3) Self-tuning indication



The point indicator at the lower right corner keeps blinking while self-tuning is underway.

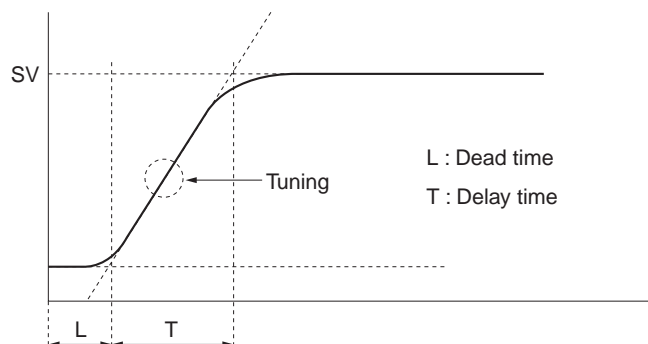

4) Self-tuning is executed by any of the following conditions.

- ① During temperature rise at power ON.
- ② During temperature rise at SV changing if necessary.
- ③ When control is out of stable condition and is judged as being out of stable condition continuously.

5) Self-tuning is not executed under the following conditions:

- ① During standby mode
- ② During ON/OFF control
- ③ During auto-tuning
- ④ During ramp/soak operation
- ⑤ During input error
- ⑥ With dual output ("P-n1" ≥ 4)
- ⑦ When P, I, D or Ar is manually set

Under the following conditions, self-tuning is canceled.

- ① When SV is changed.
- ② When Self-Tuning can not be completed in about 9 hours after the start.

6) Cautions

- Turn on the power of the whole system. The controller should be turned on at even later. Otherwise, the self-tuning might not be performed successfully.
- Don't change the SV while the self-tuning is executing.
- Once PID parameters are optimized, the self-tuning is not executed at the next power on unless SV is changed.
- After the execution of self-tuning, if the controllability is not your expected level, please select PID or FUZZY at "CTRL" parameter, and then, start the auto-tuning.

6-4 Alarm function [option]

1) Kinds of alarm

- Absolute value alarm, deviation alarm, combination alarm, and zone alarm are available.
(For details, see Table 4, Alarm action type codes on page 35.)

ON delay function

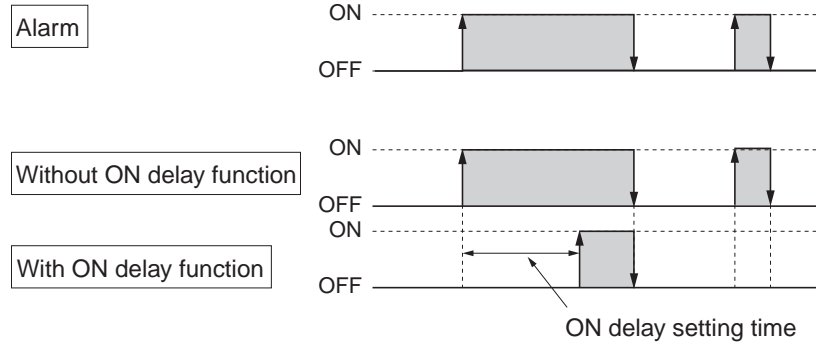

Energizing/de-energizing function

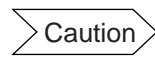
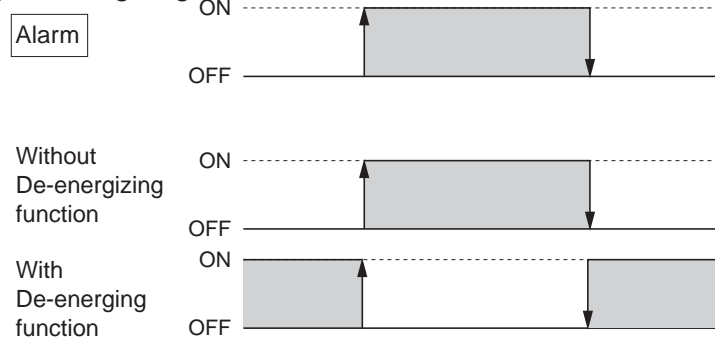

When the power is turned OFF or in Standby mode, even if de-energizing function is turned ON, it cannot be output (it is kept OFF).

2) Alarm function

No.	Function	Description	Parameters to set
①	Hysteresis	Set the hysteresis to avoid chattering.	Alarm 1 : $R1hY$ Alarm 2 : $R2hY$ Alarm 3 : $R3hY$
②	ON delay	The alarm is turned on with delay of a certain seconds as previously set after PV goes in the alarm band.	Alarm 1 : $dLY1$ Alarm 2 : $dLY2$ Alarm 3 : $dLY3$
③	Alarm latch	Keeps the alarm ON status once an alarm is turned ON. To cancel the alarm latch, please take one of the following procedure.	Alarm 1 : $R1oP$ Alarm 2 : $R2oP$ Alarm 3 : $R3oP$
		i) Turn ON the controller again.	
		ii) Turn the alarm latch settings to OFF once.	
		iii) Use alarm latch cancel parameter.	$LRCM$
		iv) Cancel by Digital input (DI).	$dC-1$ $dC-2$
④	Error status alarm	Alarm is turned on when error indications are displayed.	Alarm 1 : $R1oP$ Alarm 2 : $R2oP$ Alarm 3 : $R3oP$
⑤	De-energizing	Alarm output can be de-energized.	Alarm 1 : $R1oP$ Alarm 2 : $R2oP$ Alarm 3 : $R3oP$

Combination of alarm functions

Please see the table as shown below.

O: Possible combination

X: Impossible combination

	Without HOLD/Timer	With HOLD	With Timer
Alarm latch	O	O	X
De-energizing	O	O	O
ON delay	O	Note 1	X
Alarm in error status	X	X	X

Note 1) The alarm is not turned on the first time the measured value is in the alarm band. Instead it turns on only when the measured value goes out of the band and enters it again.

Cautions on alarms

No.	Cautions	Items/Classification
1	Note that the ON delay function is effective for alarm in error status.	Alarm in error status
2	Even during "Err" display, alarms in error status work.	Alarm at error indication
3	Even when "LLLL" or "UUUU" is displayed, an alarm function works normally.	
4	Alarm action type codes in No.12 to 15 are also included in No.24 to 27. It is, therefore, recommended to use No.24 to 27. In addition, please note when selecting No.12 to 15, setting in ALM2, dLY2, and A2hy are effective.	Alarm action type code
5	With the HB alarm, ON delay function, de-energizing function and latch function cannot be used.	HB alarm
6	The minimum alarm set value is -199.9.	Alarm set value
7	As the alarm action type changed, the alarm set value may also be changed accordingly.	
8	Note that all of alarm outputs are not provided at the standby condition.	Alarm at standby mode.
9	Error status alarm is not provided at the standby mode.	
10	The HOLD function is effective even if the PV value is in the hysteresis area when the power is turned ON.	
11	Select "0" for alarm action type code to use error status alarm.	

6-5 Ramp/soak function [option]

1. Function

Changes the set value (SV) as the time elapses according to a predetermined program pattern, as shown below.

Either 4 ramp/soak x 2 patterns or 8 ramp/soak x 1 pattern can be programmed. The first ramp starts from the process value (PV) just before the programming is executed.

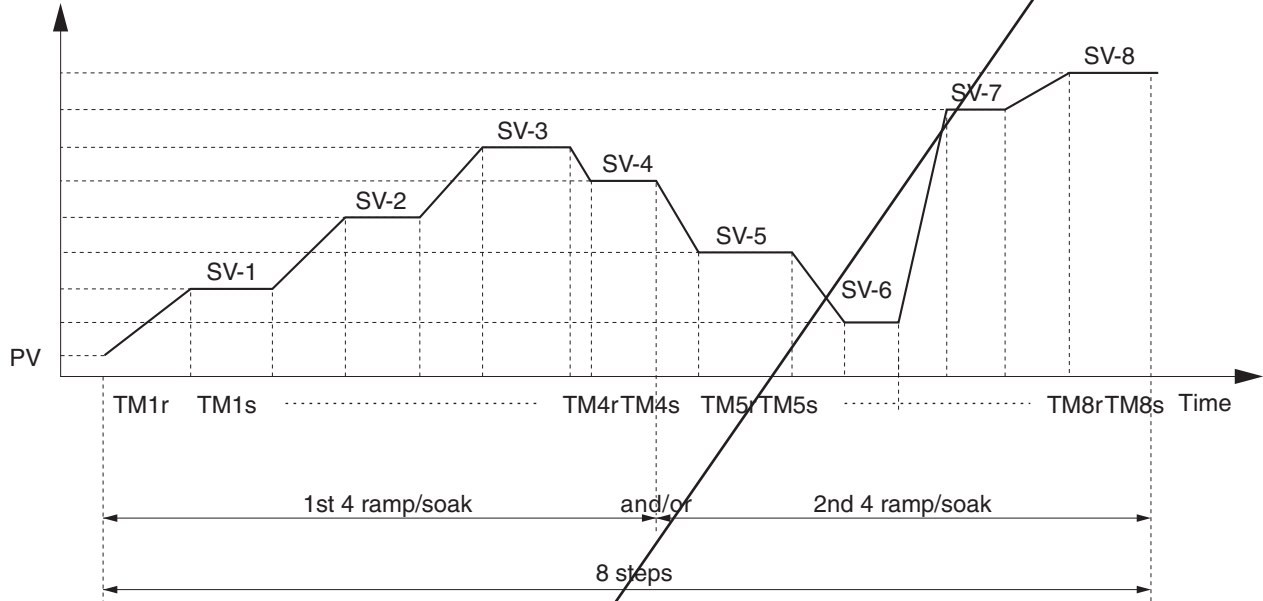

2. Setting

- Select the program pattern (PTn) and set the rUn at “ProG” parameter.
- Ramp/soak pattern can not be changed while ramp/soak program is running.

PTn	Pattern	Ramp/Soak
1	1	4
2	2	4
3	1 + 2	8

Note:

- The ramp/soak program is canceled if the controller becomes to standby mode. Then, if the controller becomes to operation mode, the program doesn't run again.

6-6 Communication function [option]

1) Function

- Internal data can be read/written via MODBUS or ASCII communications.

2) To use the function, the following three parameters must be set.

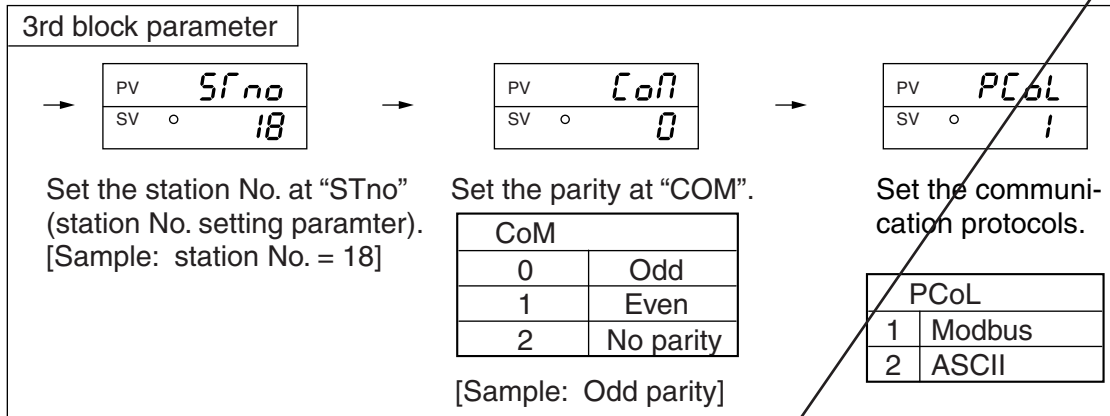

3) Caution

- Station No. can be set in the range of 0 to 255. (No communication is allowed when Modbus is selected, or Stno=0.)
- After changing the setting of parity at "COM", please power off and re-start the controller.
- Baud rate is fixed to 9600 bps.

6-7 Digital input (DI function) [option]

1) Function

- With Digital input, the following functions are available.
- q SV switching
- w Control mode; RUN/STANDBY selection
- e Ramp/soak RUN/RESET selection
- r Auto-tuning start/stop
- t Alarm latch cancel
- y Timer start/reset

2) To use DI function;

- Select the function with the parameter “di-1” or “di-2” referring to the Table shown below.

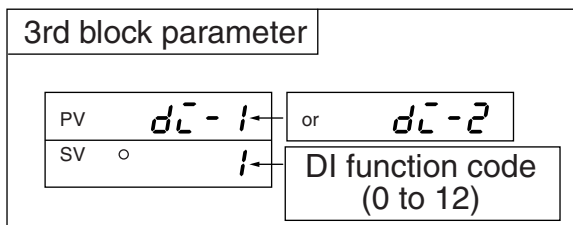

3) Table of DI function

DI function code	Function	Description
1	Set value (SV) switching	Switching between local SV and “S \bar{v} -1” “S \bar{v} -2” “S \bar{v} -3”
2	Control mode, RUN/STANDBY	At standby mode, control is not provided and SV flickers.
3	Auto-tuning (standard) start	Start/Stop can be switched at the time of DI raising up or dropping down.
4	Auto-tuning (low PV) start	
5	All alarm latch cancel	When this function is not used, DI is not effective.
6	Alarm 1 latch cancel	
7	Alarm 2 latch cancel	
8	Alarm 3 latch cancel	
9	ALM1 timer	ON/OFF delay timer operation is available. The remaining time of the timer can be checked with timer-1 and -2 display parameters (first block).
10	ALM2 timer	
11	ALM3 timer	
12	Ramp/soak RUN/RESET	RUN/RESET of ramp/soak can be performed at the time of DI raising up or dropping down.

6-8 Other functions

The parameters “bAL” and “Ar” are masked at default setting.

If necessary to appear these parameters, please refer to the following procedure.

1) Function

- “bAL” and “Ar” are functions to suppress overshoot.
(Usually it is not necessary to change the setting.)

2) If they aren't optimum value, sometime you don't get the good control. Usually it is not necessary to set them.

3) “Ar” (Anti-reset wind-up) is automatically set by “Auto tuning”.

1 bAL

MV is calculated by adding the offset (bAL) to MV', the result of PID calculation, from PV and SV.

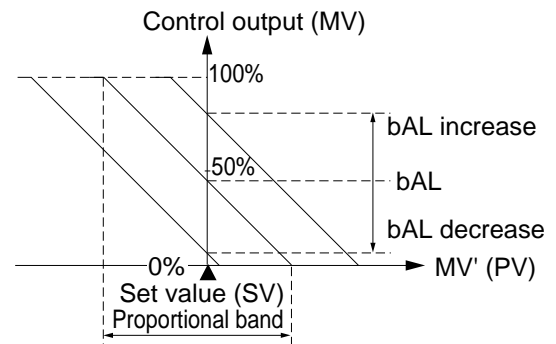
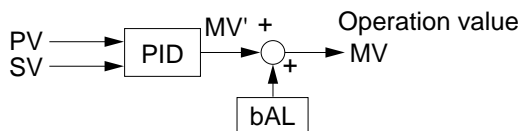

Integral action

2 Ar

The integral range is $SV \pm Ar$.

Integral action don't work when PV is out of the range.

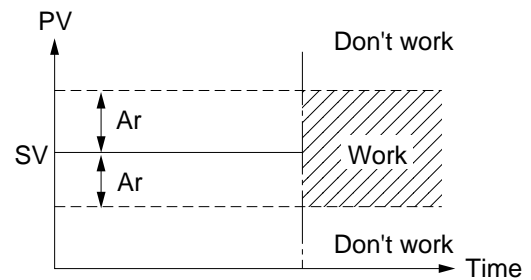

Mask/Unmask bAL and Ar

1 To unmask

- ① Display the “dSP3” in the third block parameter and then subtract 128 from current value.
- ② Display the “dSP4” in the third block parameter and then subtract 1 from current value.

2 To mask

- ① Display the “dSP3” in the third block parameter and then add 128 to current value.
- ② Display the “dSP4” in the third block parameter and then add 1 to current value.

6-9 Re-transmission output function

1) Function

Outputs PV, SV, MV, and DV as a unified 4 to 20mA signal.

2) To use the Re-transmission output function,

(1) Set the output type to be outputted to Re-transmission output at R_{O-T} .

Ao-T	Output type
0	PV
1	SV
2	MV
3	DV

(2) If output scaling is required, make the scaling setting at R_{O-L} and R_{O-H} .

6-10 Remote SV function

1) Function

Controls SV (set value) by inputting 1 to 5V voltage signals by an external device.

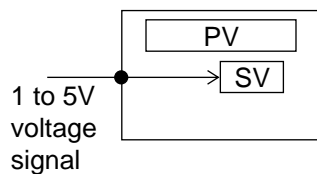

2) To perform remote operation.

(1) Connect the remote SV voltage signal to the remote SV input terminal.

(2) If required, perform zero point or span point adjustment of remote SV input.

r_{EN0} ... Parameter for zero point compensation of remote SV input

r_{EN5} ... Parameter for span point compensation of remote SV input

(3) Changing r_{Mod} parameter to L_{oLL} → r_{EN} switches to remote SV operation.

* r_{dF} is the setting for remote SV input filter. Use the equipment with the value set to 0.0 (set at the time of delivery) unless the change is required.

7

Setting of input type and control algorithm

1 Setting of the input type

* Skip this procedure if the input type is specified when you order.

① Please check if the input type set at "P-n2" is same as what you use.

Choose the sensor type you use from Table 1 shown below, and set the code at "P-n2".

(Example) For T thermo-couple, set "P-n2"=7.

(Note) Please refer to the following table for the modification of the input type.

TC ←————→ RTD (within Group I)*	Can be modified by changing "P-n2".
TC/RTD ←————→ 1 to 5Vdc (Group I)* 4 to 20mAdc (Group II)*	Modification not possible

TC : Thermocouple RTD : Resistance bulb (*Please refer to table 1)



② Is setting of input temperature range suitable for the sensor you use?

Standard range to each sensor is shown in Table 3. Select the temperature range suitable for the equipments you use, set lower/upper limit values to "P-SL" / "P-SU" respectively.

(Example) For temperature range 0 to 800 [°C] : Set "P-SL" and "P-SU" to 0 and 800 respectively.

(Note) If the span of setting ranges is smaller than the one of minimum standard range, the accuracy (% full scale) is influenced.

(Note) No standard range is given in case of 1 to 5VDC (4 to 20mA DC) input. Please set the range within the following limitation.

- Maximum span : 9999
- Lower limit : -1999
- Upper limit : 9999

Note:

Please set "P-n2": Input sensor type and "P-SL/P-SU/P-dP": input range setting prior to any other parameter settings. When "P-n2" and/or "P-SL/P-SU/P-dP" is changed, some other parameters may also be influenced. Please check all parameters before starting control.

2 Setting of the algorithm

* Read if the control doesn't work as you expect.

① Select the type of control output action.

	Control output action	Description	Setting procedure
Heating	Reverse	As PV increases, MV decreases. As PV decreases, MV increases.	Set parameter "P-n1" = 0 or 1. (Refer to Table 2)
Cooling	Direct	As PV increases, MV also increases. As PV decreases, MV also decreases.	Set parameter "P-n1" = 2 or 3. (Refer to Table 2)



② Control algorithm (ON/OFF, PID or fuzzy)

Type of control	Description	Setting procedure
ON/OFF control	Output is either ON (100%) or OFF (0%). (Suitable when frequent output switching is inconvenient.)	Set "P" =0.0. Refer to "6-1 ON/OFF control".
PID control	The output signal changes within the range at 0 to 100% according to PID calculation which determine the proportional of ON to OFF in each TC (cycle time).	Select PID at "CTrL". Execute auto-tuning so that optimum P.I.D can be calculated automatically. (PID parameters can be set spontaneously). *Refer to "6-2 Auto-tuning".
Fuzzy control	Fuzzy operation is added to PID providing control with less overshoot.	Select FUZY at "CTrL". Then execute the auto-tuning so that FUZZY control starts.
PID control with self-tuning.	At power on, changing a set value or the external disturbance, tuning is made automatically so that the PID parameters are re-optimized. It is useful where modification of PID parameters is required repeatably due to frequent change in process condition.	Select SELF at "CTrL". Refer to "6-3 Self-tuning".

8

Error indications

Error indications

This controller has a display function to indicate several types of error code shown below.

If any of the error codes is displayed, please eliminate the cause of error immediately.

After the cause is eliminated, turn off the power once, and then re-start the controller.

Error code	Possible cause	Control output	Group
UUUU	<ul style="list-style-type: none"> ① Thermocouple burnt out. ② RTD (A) line burnt out. ③ PV value exceeds P-SU by 5% FS. 	<ul style="list-style-type: none"> ① when the burn-out control output is set as the lower limit (standard): OFF or 4 mA or less 	I
LLLL	<ul style="list-style-type: none"> ① The RTD line (B or C) burnt out. ② The RTD line (between A and B or A and C) short. ③ PV value is below P-SL by 5%FS. ④ 1 to 5 VDC or 4 to 20mA DC wiring open or short. 	<ul style="list-style-type: none"> ② when the burn-out control output is set as the upper limit: ON or 20 mA or larger 	
LLLL	<ul style="list-style-type: none"> ① PV value < -199.9 <p>Note) In case of RTD input, "LLLL" is not displayed even if the temperature becomes below -150 °C.</p>	Control is continued until the value reaches -5% FS or less, after which burn-out condition will occur.	II
AL3 lamp lit	Break of the heater (when provided with heater break alarm)	Normal control	
Err (SV indication flickers)	Incorrect range setting (P-SL/P-SU).	OFF or 4mA or less	
PV not displayed	Incorrect DP13 setting. Add 64 to set value of DP13 to display PV.	Normal control	

[Table 1] Input type code

Parameter : P-n2

Group	Input type	Code
I	RTD	1
	· Pt100 (IEC)	
	Thermocouple	2
	· J	
	· K	
	· R	
	· B	
	· S	
	· T	
	· E	
	· N	
	· PL-II	
	13	

· Input signals can be selected within the same group.

TC	↔	RTD	Can be modified by changing "P-n2".
(within Group I)*			

[Table 2] Control output action code

Parameter : P-n1

Code	Output	Control output action		Output at Burn-out*	
		Output 1	Output 2	Output 1	Output 2
0	Single (Control output 1)	Reverse action	---	Lower limit	---
1				Upper limit	
2		Direct action		Lower limit	
3				Upper limit	
4	Dual [Control output 1 and 2.]	Reverse action	Direct action	Lower limit	Lower limit
5				Upper limit	Upper limit
6				Lower limit	Lower limit
7				Upper limit	Upper limit
8				Lower limit	Lower limit
9				Upper limit	Upper limit
10		Direct action	Reverse action	Lower limit	Lower limit
11				Upper limit	Upper limit
12				Lower limit	Lower limit
13				Upper limit	Upper limit
14				Lower limit	Lower limit
15				Upper limit	Upper limit
16	Direct action	Reverse action	Lower limit	Lower limit	
17			Upper limit	Upper limit	
18			Lower limit	Lower limit	
19			Upper limit	Upper limit	

(*) Outputs when Error Indication Group I. Please refer to "8. Error indications". This is effective even in Standby mode.

Lower limit: OFF or 4mA or less
Upper limit: ON or 20mA or more

[Caution for dual output] (option)

- (1) Parameter "I" and "D" can not be set separately.
- (2) In case "P"=0 (ON/OFF control) for heating side, cooling side becomes ON/OFF control automatically.
- (3) In case "Cool" =0.0, cooling side becomes ON/OFF control. And hysteresis is fixed at 0.5%FS.

[Table 3] Input range (Standard range)

Parameter : P-SL, P-SU, P-dP

Input signal type		Range (°C)	Range (°F)	Input signal type		Range (°C)	Range (°F)
RTD (IEC)	Pt100Ω	0 to 150	32 to 302	Thermo-couple	R	0 to 1600	32 to 2912
	Pt100Ω	0 to 300	32 to 572		B	0 to 1800	32 to 3272
	Pt100Ω	0 to 500	32 to 932		S	0 to 1600	32 to 2912
	Pt100Ω	0 to 600	32 to 1112		T	-150 to 200	-238 to 392
	Pt100Ω	-50 to 100	-58 to 212		T	-150 to 400	-238 to 752
	Pt100Ω	-100 to 200	-148 to 392		E	0 to 800	32 to 1472
	Pt100Ω	-150 to 600	-328 to 1112		E	-150 to 800	-238 to 1472
	Pt100Ω	-150 to 850	-328 to 1562		N	0 to 1300	32 to 2372
Thermo-couple	J	0 to 400	32 to 752		PL-II	0 to 1300	32 to 2372
	J	0 to 800	32 to 1472		DC voltage	1 to 5VDC	-1999 to 9999 (Scaling is possible) • Maximum span : 9999 • Lower limit : -1999 • Upper limit : 9999
	K	0 to 400	32 to 752				
	K	0 to 800	32 to 1472				
	K	0 to 1200	32 to 2192				

Note 1) Except for the following, the input accuracy is $\pm 0.5\%$ FS ± 1 digit ± 1 °C (Input accuracy does not be guaranteed for the ranges of measurement other than in the table above.)
R thermocouple 0 to 500 °C } . in these ranges, this controller may display an incorrect
B thermocouple 0 to 400 °C } process value due to the characteristic of the sensor.

Note 2) In case a measuring range of -150 to 600 °C or -150 to 850 °C is used for resistance bulb input, temperatures below -150 °C does not be indicated correctly. Therefore, "LLLL" does not appear despite a continuous fall below -150 °C.

Note 3) If the resistance bulb or thermocouple is used at a temperature below the lowest value in the measurement range, the input accuracy cannot be guaranteed.

Note 4) Addition of decimal point is impossible if the input range or span is larger than 999.9 at the RTD/thermocouple input.

[Table 4] Alarm action type code

Parameter : ALN1, ALN2, ALN3

· Standard alarm code

	ALM 1	ALM 2	ALM 3	Alarm type	Action diagram
	0	0	0	No alarm	
Absolute value alarm	1	1	1	High alarm	
	2	2	2	Low alarm	
	3	3	3	High alarm (with hold)	
	4	4	4	Low alarm (with hold)	
Deviation alarm	5	5	5	High alarm	
	6	6	6	Low alarm	
	7	7	7	High/Low alarm	
	8	8	8	High alarm (with hold)	
	9	9	9	Low alarm (with hold)	
	10	10	10	High/Low alarm (with hold)	
Zone alarm	11	11	11	High/Low deviation alarm (ALM1/2 independent action)	
	-	12	-	High/Low absolute alarm	
	-	13	-	High/Low deviation alarm	
	-	14	-	High absolute /Low deviation alarm	
	-	15	-	High deviation /Low absolute alarm	

· Timer code

	ALM 1	ALM 2	ALM 3	Alarm type	Action diagram
Timer	32	32	32	ON delay timer	
	33	33	33	OFF delay timer	
	34	34	34	ON/OFF delay timer	

· Alarm code with dual set value

	ALM 1	ALM 2	ALM 3	Alarm type	Action diagram	
High /Low limit alarm	16	16	16	High/Low absolute alarm		
	17	17	17	High/Low deviation alarm		
	18	18	18	High absolute /Low deviation alarm		
	19	19	19	High deviation /Low absolute alarm		
	20	20	20	High/Low absolute alarm (with hold)		
	21	21	21	High/Low deviation alarm (with hold)		
	22	22	22	High absolute /Low deviation alarm (with hold)		
	23	23	23	High deviation /Low absolute alarm (with hold)		
	Zone alarm	24	24	24	High/Low absolute alarm	
		25	25	25	High/Low deviation alarm	
26		26	26	High absolute /Low deviation alarm		
27		27	27	High deviation /Low absolute alarm		
28		28	28	High/Low absolute alarm (with hold)		
29		29	29	High/Low deviation alarm (with hold)		
30		30	30	High absolute /Low deviation alarm (with hold)		
31		31	31	High deviation /Low absolute alarm (with hold)		

Point

What is alarm with hold?

The alarm is not turned ON immediately even when the process value is in the alarm band. It turns ON when it goes out the alarm band and enters again.

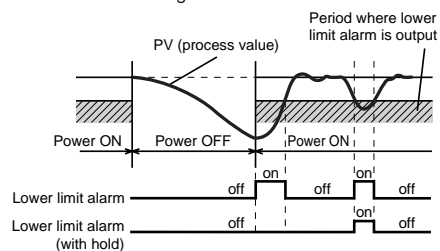

Note) · When alarm action type code is changed, alarm set value may also become different from previous settings.

Please check these parameters, turn off the power once, and then re-start the controller, before starting control.

- When selecting No.12 to 15, setting in ALM2, dLY2, and A2hy are effective, and output to the AL2 relay.
- ALn means alarm set value (AL1, AL2 or AL3).
- An-H means alarm set value (A1-H, A2-H or A3-H).
- An-L means alarm set value (A1-L, A2-L or A3-L).
- dLYn means alarm set value (dLY1, dLY2 or dLY3).

[Table 5] Control operation type code

Parameter : *Mod*

[MOD code list]

MOD	Power ON start	Output at END	Output at OFF	Repeat operation
0	Without	Control continued	Control continued	Without
1	Without	Control continued	Control continued	With
2	Without	Control continued	Standby mode	Without
3	Without	Control continued	Standby mode	With
4	Without	Standby mode	Control continued	Without
5	Without	Standby mode	Control continued	With
6	Without	Standby mode	Standby mode	Without
7	Without	Standby mode	Standby mode	With
8	With	Control continued	Control continued	Without
9	With	Control continued	Control continued	With
10	With	Control continued	Standby mode	Without
11	With	Control continued	Standby mode	With
12	With	Standby mode	Control continued	Without
13	With	Standby mode	Control continued	With
14	With	Standby mode	Standby mode	Without
15	With	Standby mode	Standby mode	With

[Description of functions]

1. Power ON start: Starts ramp/soak with the current PV value.
2. Output at END: Displays the output status at the time when ramp/soak is at END.
3. Output at OFF: Displays the output status at the time when ramp/soak is at OFF.
4. Repeat operation: After the ramp/soak step is terminated once, runs ramp/soak repeatedly.
The PV value set in the previous step is maintained in normal state (without repeat operation).

* Standby mode: Output -3%

Alarm OFF

Standby mode where no control operation is performed.

Specification

Power voltage:	100 (-15%) to 240V AC (+10%) 50/60Hz,
Power consumption:	10VA or less (at 100V AC), 12VA or less (at 220V AC),
Relay contact output:	Control output 1: SPDT contact, 220V AC /30V DC 3A (resistive load)
SSR/SSC driving output *1: (voltage pulse output)	ON: 24V DC (17 to 25V DC) OFF: 0.5V DC or less Maximum current ; 20mA or less Resistive load 850Ω or more
4-20mA DC output:	Allowable load resistor 600Ω or less
Alarm output (up to 2 outputs):	Relay contact (SPST contact) 220V AC / 30V DC 1A (resistive load)
Heater disconnection alarm output:	Relay contact (SPST contact) 220V AC / 30V DC 1A (resistive load)
Communication function *2:	RS-485 interface Transmission system ; Half-duplex 1 bit serial start-stop synchronization Transmission rate ; 9600bps Transmission protocol ; In conformity to Modbus RTU or Z-ASCII Transmission distance ; Up to 500m (total length) Connectable units ; Up to 31units
Digital input :	Number of inputs; 2 inputs Judged as ON : 3VDC or higher Judged as OFF : 2VDC or lower Input contact capacity ; 5V, 2mA DC Input pulse width ; Min 0.5 sec
Re-transmission output:	Output accuracy ±0.3% or lower Permissible load resistance 600Ω or less
Remote SV input:	Input accuracy ±0.5% FS or lower (Without input break detection function) Set resolution 3000 or higher Input filtering function provided
Ambient temperature:	-10 to 50°C -10 to 45°C (when side by side mounting)
Operating ambient humidity:	90%RH or less (no condensation)
Preservation temperature:	-20 to 60°C
Time accuracy:	Within ±0.5%

Input signal, measurement range, and set value at the time of deliver are as follows.

When thermocouple is specified: Thermocouple K, Measurement range; 0 to 400°C, Set value; 0°C

Input signal of the thermocouple and the resistance bulb can be switched by key operation on the front panel.

The actuating method of the control output has been set to reverse for control output 1

Note that reverse and direct actuation can be switched by key operation on the front panel.

*1 :

	SSR/SSC driving output		Allowable load resistance for 4 to 20mA DC output
	Voltage	Maximum current	
48CSP2D	24V DC	20mA	600Ω or less

*2 : A communication converter is required to connect this product with PC.

Modbus RTU : A trademark of Modicon Corp.,USA